

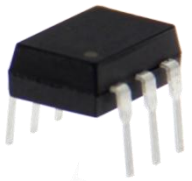

产品图片	Features产品特性	Application应用
 DIP6	<ul style="list-style-type: none"> ●Contact Form 触点形式 1a ●Load Voltage 输出电压 400V ●Load Current 输出电流 140mA ●Low Off-State Leakage Current 漏电流 1.0 μA 	<ul style="list-style-type: none"> ●Automatic Test Equipment 自动检测设备 ●Security Equipment 安全设备 ●Sensing Equipment 传感设备 ●Telephone Equipment 通信设备 ●I/O Modules I/O模块 ●Modem 调制解调器
 SMD6		

Type 种类

Output rating输出额定		Marking model标 刻型号	Part No. 订货型号	
Load voltage负 载电压	Load current 负载电流		DIP 双列直插	SMD 表面贴装
400V	0.14A	BCV214	BCV214	BCV214A

注：表示引脚类型的“A”未标刻在产品上，订货依据订货示例型号。

Dimensions外形尺寸

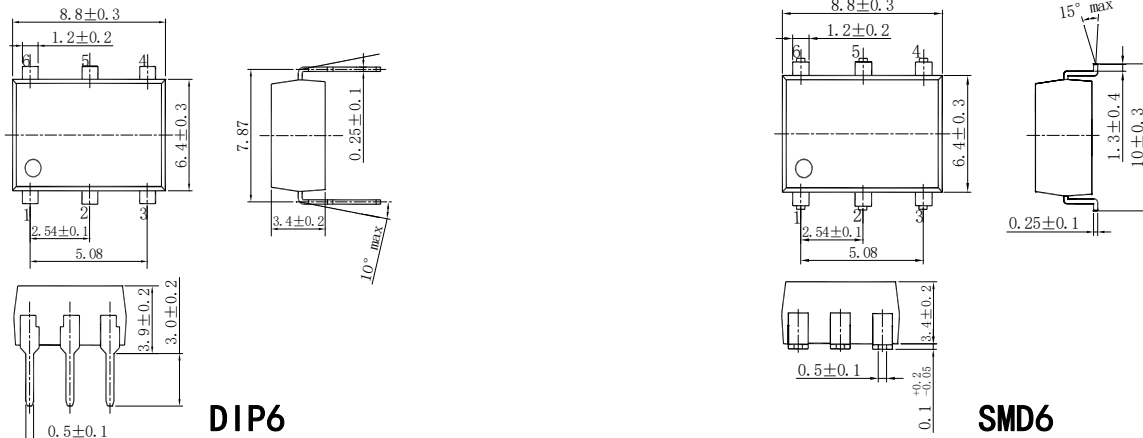

Terminal Identification引脚标识

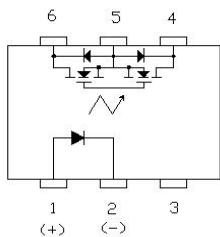

Wiring Diagram 接线图

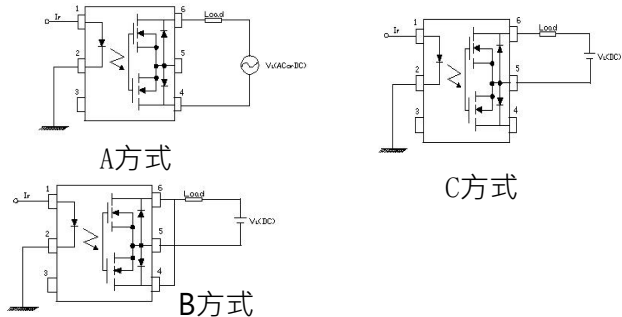

通讯地址：陕西省西安市国家民用航天产业基地航天中路385号众创广场11层1101、1102、1104室

生产地址：陕西省宝鸡市陈仓区群力路1号 邮政编码：721300

电话：(0917)-6293969 (0917)-6293785 传真：(0917)-6293969



BCV214型光MOS继电器

Technical parameters技术参数 (Ambient Temperature 25°C)

I/O Absolute Maximum Ratings输入输出电气参数最大值

Item项目		Symbol符号	Value数值
Operating Temperature工作温度		T_{OPR}	-40°C~+85°C
Storage Temperature储存温度		T_{STG}	-40°C~+100°C
Input输入	Continuous LED Current工作电流	I_F	50mA
	Peak LED Current LED峰值电流 (f=100Hz, Duty=1%)	I_{FP}	1000mA
	LED Reverse Voltage反向电压	V_R	5V
	Input Power Dissipation输入功耗	P_{IN}	75mW
Output输出	Load Voltage输出电压	V_L	400V (AC peak or DC)
	Load Current输出电流	I_L	140mA
	Peak Load Current峰值输出电流 (100ms, 1 shot)	I_{PEAK}	0.6A
	Output Power Dissipation输出功耗	P_{OUT}	300mW
Total Power Dissipation总功耗		P_T	350mW
I/O Breakdown Voltage输入输出间隔离电压 (RH=10%, 1 min)		$V_{I/O}$	3750Vrms
I/O Breakdown Voltage输入输出间隔离电压 (加注H)		$V_{I/O}$	5000Vrms

Electrical Specifications输入输出电气参数

Item项目		Symbol符号	MIN.最小值	TYP.典型值	MAX.最大值	Units单位	Conditions条件
Input输入	LED Forward Voltage正向电压	V_F		1.2	1.4	V	$I_F=10mA$
	Operation LED Current接通电流	$I_{F ON}$		0.5	3.0	mA	
	Recovery LED Voltage关断电压	$V_{F OFF}$	0.5			V	
Output输出	On-Resistance导通电阻	R_{ON}		20	30	Ω	$I_F=5mA, I_L=100mA$ (within 1sec.)
	Off-State Leakage Current漏电流	I_{LEAK}			1.0	μA	$V_L=Rating$
	Output Capacitance输出端容量	C_{OUT}		110		pF	$V_L=0V, f=1MHz$
Time parameters时间参数	Turn-On Time接通时间	T_{ON}		0.5	1	ms	$I_F=5mA$ $I_L=100mA$
	Turn-Off Time关断时间	T_{OFF}		0.03	0.5	ms	
I/O输入输出	I/O Insulation Resistance绝缘电阻	$R_{I/O}$	1000			M Ω	DC500V
	I/O Capacitance隔离电容	$C_{I/O}$		0.8	1.5	pF	f=1MHz

通讯地址：陕西省西安市国家民用航天产业基地航天中路385号众创广场11层1101、1102、1104室

生产地址：陕西省宝鸡市陈仓区群力路1号 邮政编码：721300

电话：(0917)-6293969 (0917)-6293785 传真：(0917)-6293969



BCV214型光MOS继电器

Reference Data 参考数值 (BCV214)

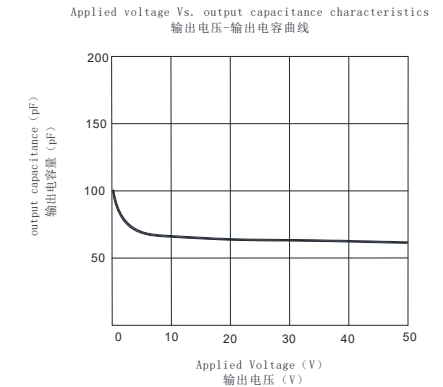
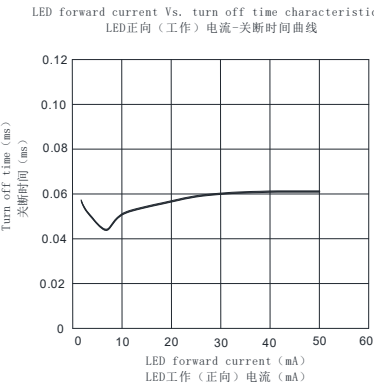
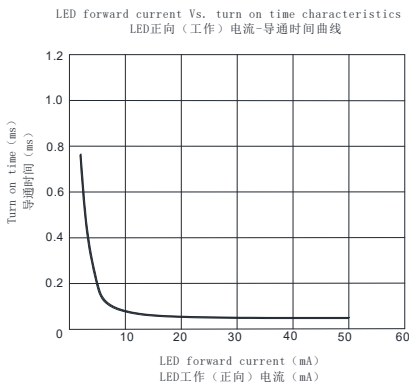
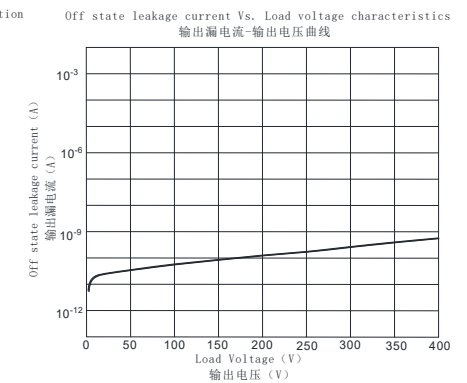
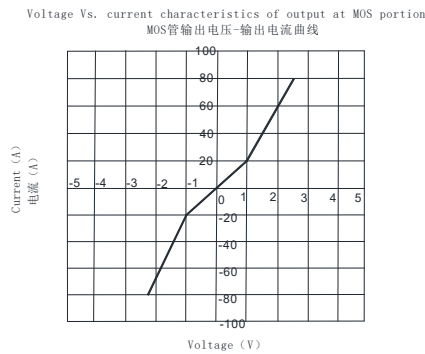
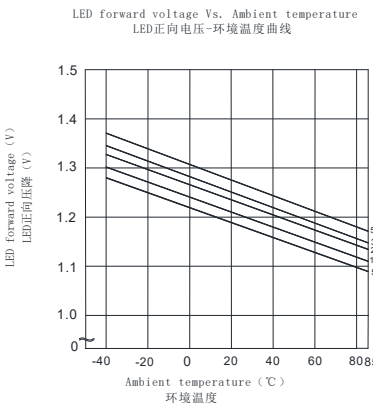
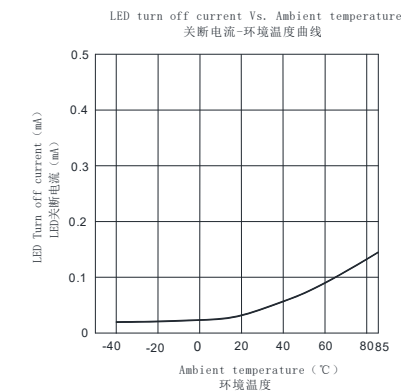
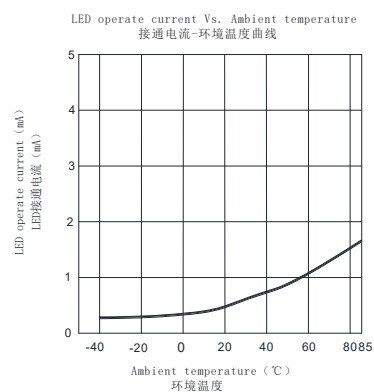
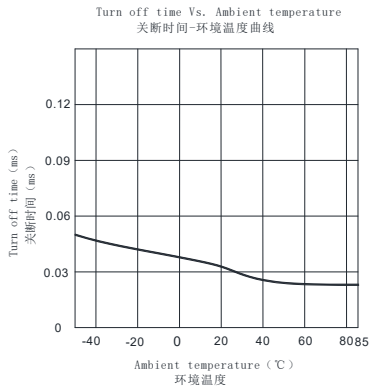
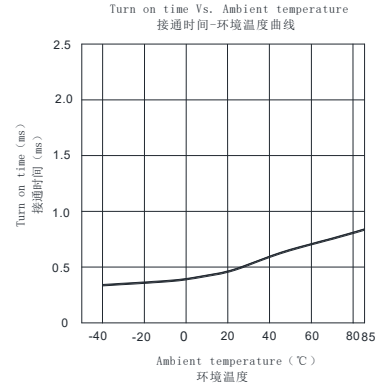
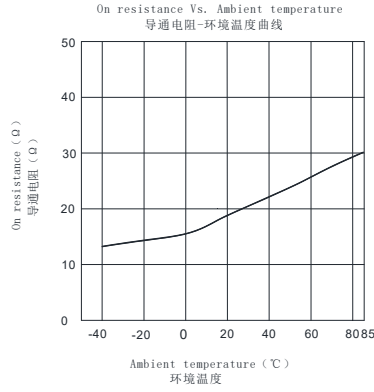
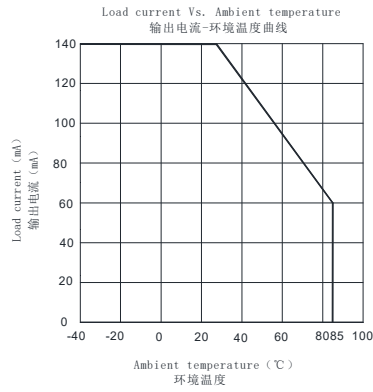

通讯地址: 陕西省西安市国家民用航天产业基地航天中路385号众创广场11层1101、1102、1104室

生产地址: 陕西省宝鸡市陈仓区群力路1号 邮政编码: 721300

电话: (0917)-6293969 (0917)-6293785 传真: (0917)-6293969